

PE silo stand 90 L

Art.nr: 90-2S-PE

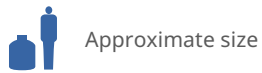

Specifications	
Material	PE
Color	Black
Height (mm)	970
Diameter (mm)	500

Characteristics



Recyclable



Wide temperature range



Chemical resistance



Leak test



Logistics solutions



Suitable for food contact



Easy to clean

Revision		
REV.	Ändringsmeddelande	Datum
		Godkänd

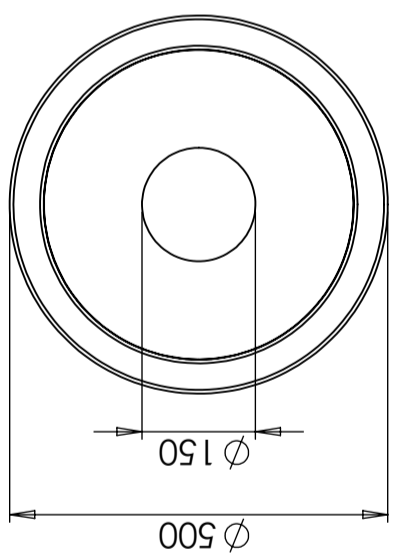
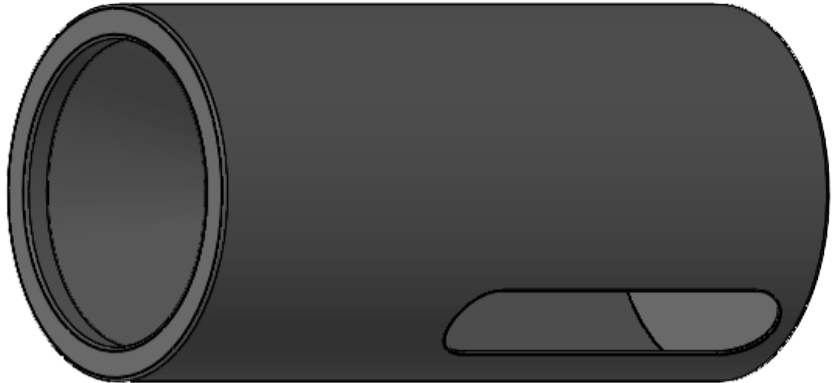
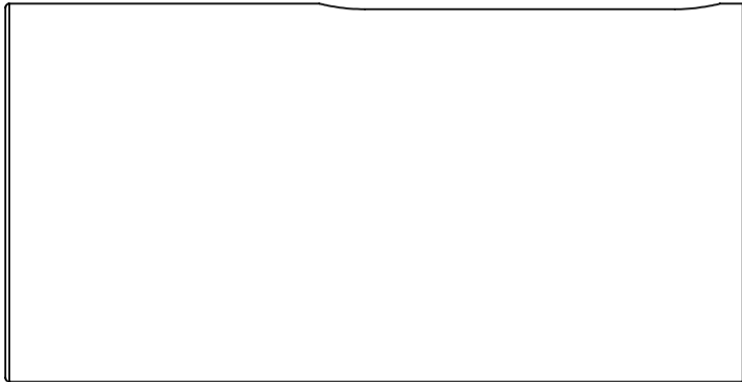
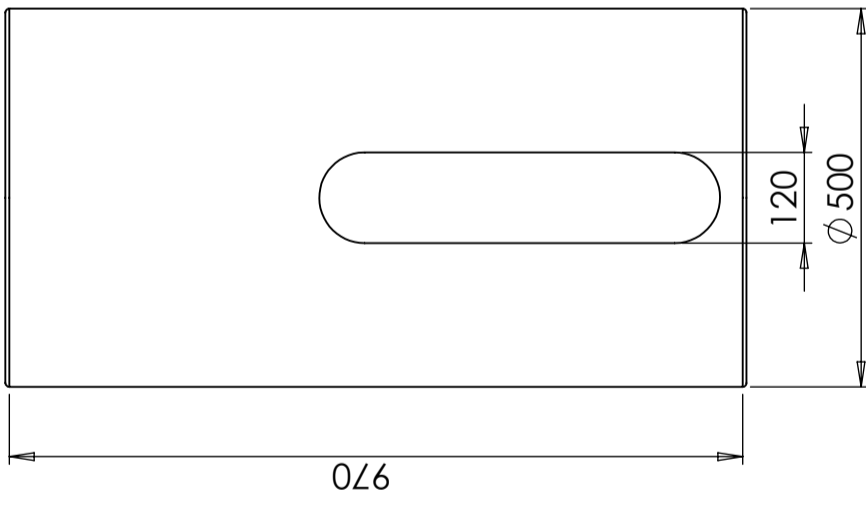
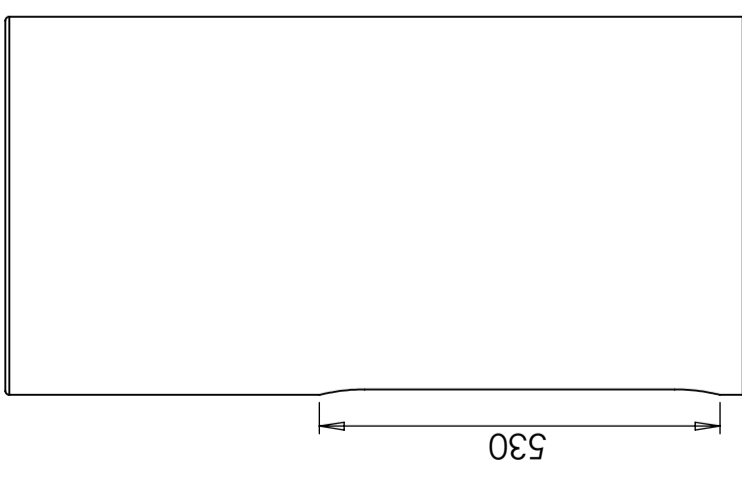
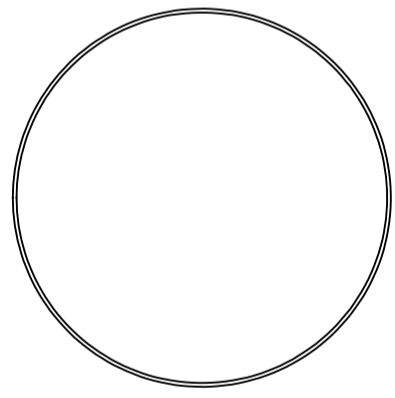

Konstruerad av	Granskad av	Godkänd av - datum	Generell tolerans SS-ISO 2768-1	Generell Ytjämnhet, Ra	Vyplacering	Skala
		-				1:10
			Titel/Benämning			
Ägare			Stativ silo 90L PE			
			Ritningsnummer			
			69400			
			Utgåva			
			A			
			Blad			
			1(1)			