

# PE-Gestell für Silo 90 L

Art.-Nr.: 90-2S-PE



Ungefähre Größe

Spezifikationen	
Material	PE
Farbe	Schwarz
Höhe (mm)	970
Durchmesser (mm)	500

## Eigenschaften



Recyclbar



Großer  
Temperaturbereich



Chemikalienbeständig



Dichtigkeitsprüfung



Logistiklösung



An Lebensmittel angepasst



Einfach zu reinigen

Revision		
REV.	Ändringsmeddelande	Datum
		Godkänd

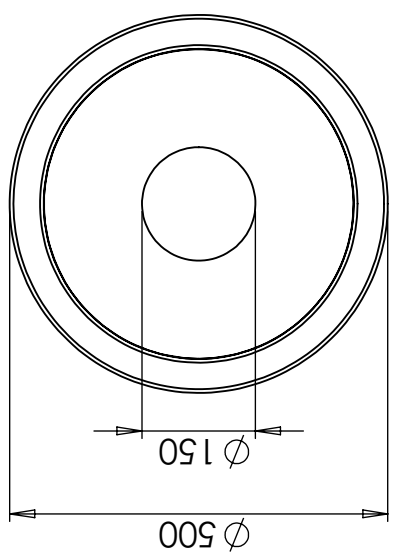
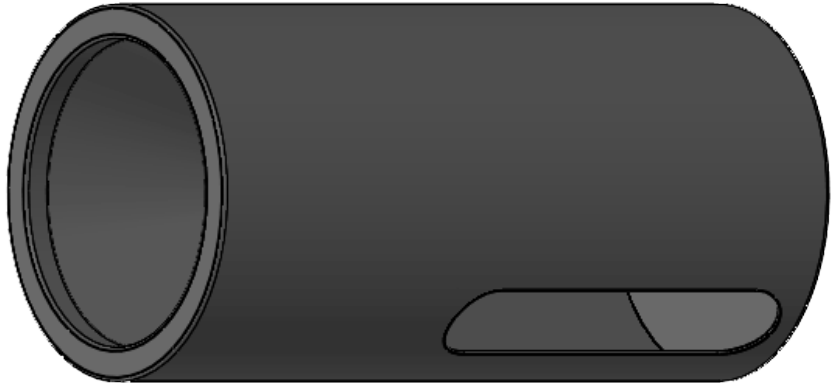
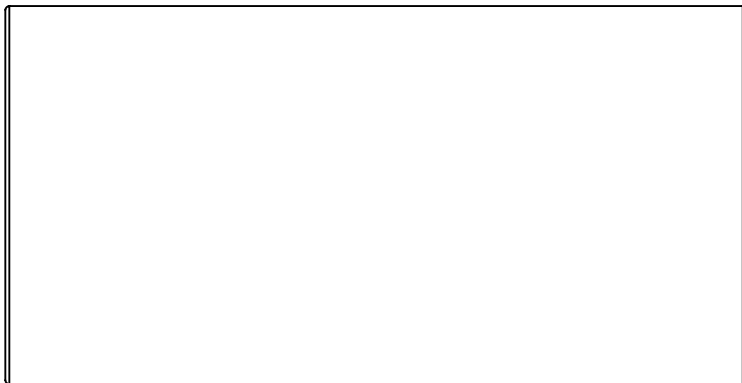
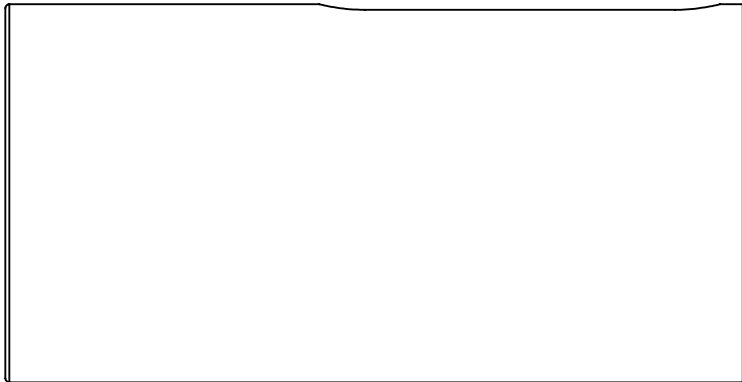
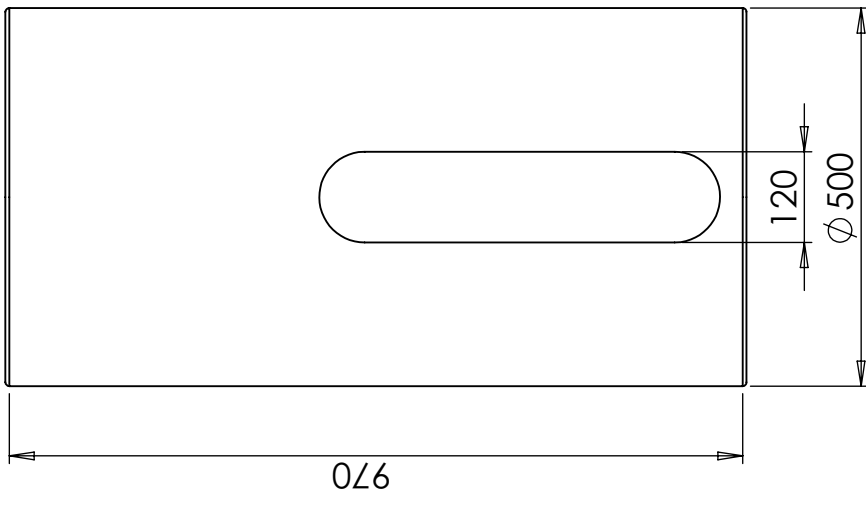
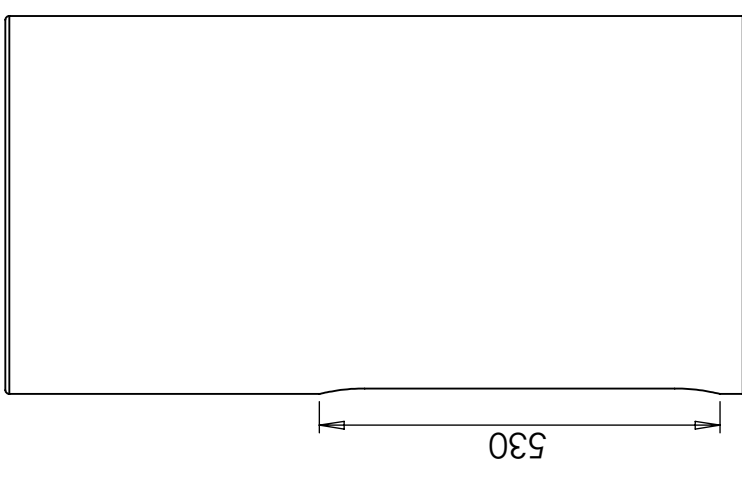
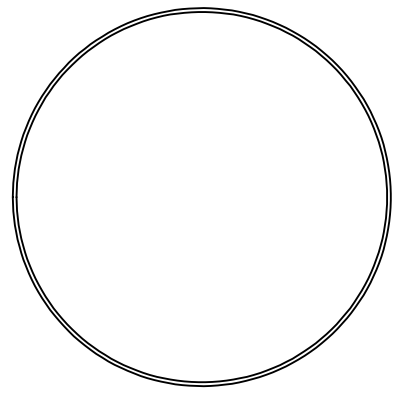

Konstruerad av	Granskad av	Godkänd av - datum	Generell tolerans SS-ISO 2768-1	Generell Ytjämnhet, Ra	Vyplacering	Skala
		-				1:10
			Titel/Benämning			
Ägare			Stativ silo 90L PE			
			Ritningsnummer			
			69400			
			Utgåva			
			A			
			Blad			
			1(1)			